



Series | Flat vacuum cups SF

High-temperature Thermalon® cups – SKT-F

High-temperature Thermalon® cups – SKT-F



UP TO 160 °C (320 °F) & MINIMUM MARKING

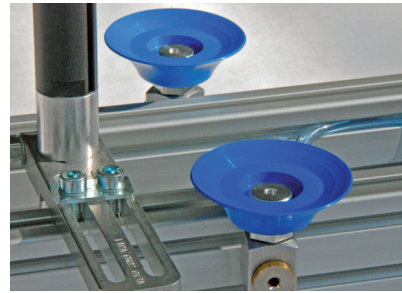

Product notes

Flat vacuum cups for smooth surfaces especially suitable for removing hot plastic parts to be painted from an injection molding machine. Thermalon® is a material mixture specially optimized for the plastics industry with a hardness of 60° Shore A. Connection up to Ø 50 mm by means of plug-in nipple, from Ø 60 mm with vulcanized carrier plate (boltable).



Advantage

- > Extremely low-marking
- > Free of silicone and other paint-wetting-impairment substances (PWIS)
- > Great stability allows high acceleration

Technical data

Item no.	Model		Material / Color	Short-term working temperature < 30 Sec [°C (°F)]
102.005.496.19	SKT-F-5	1	Thermalon® (bl)	0 - 160 (32 - 320)
102.008.497.19	SKT-F-8	1.4	Thermalon® (bl)	0 - 160 (32 - 320)
102.010.498.19	SKT-F-10	1.5	Thermalon® (bl)	0 - 160 (32 - 320)
102.015.499.19	SKT-F-15	2	Thermalon® (bl)	0 - 160 (32 - 320)
102.020.500.19	SKT-F-20	2.5	Thermalon® (bl)	0 - 160 (32 - 320)
102.025.501.19	SKT-F-25	3	Thermalon® (bl)	0 - 160 (32 - 320)
102.030.502.19	SKT-F-30	2	Thermalon® (bl)	0 - 160 (32 - 320)
102.040.503.19	SKT-F-40	4	Thermalon® (bl)	0 - 160 (32 - 320)
102.050.504.19	SKT-F-50	4	Thermalon® (bl)	0 - 160 (32 - 320)
102.060.505.19	SKT-F-60	4	Thermalon® (bl)	0 - 160 (32 - 320)
102.080.304.19	SKT-F 80	6	Thermalon® (bl)	0 - 160 (32 - 320)
102.095.305.19	SKT-F 95	6	Thermalon® (bl)	0 - 160 (32 - 320)

Accessories

Item no.	 Suitable fittings							 Suitable spring leveler (Snap-in)	
	M5-male	M5-female	M6-male	G1/8-male	G1/8-female	G1/4-male	G1/4-female	Spring leveler	
102.005.496.19	270.010	270.005	--	270.009	270.007	--	--	50.330	9
102.008.497.19	270.010	270.005	--	270.009	270.007	--	--	50.330	9
102.010.498.19	270.010	270.005	--	270.009	270.007	--	--	50.330	9
102.015.499.19	270.200	--	--	270.064	270.065	--	--	50.330	9
102.020.500.19	270.311	--	--	270.063	270.061	--	--	--	--
102.025.501.19	--	--	270.312/19	270.030	270.019	270.274	270.275	--	--



Accessories

Item no.	Suitable fittings							Suitable spring leveler (Snap-in)	
	M5-male	M5-female	M6-male	G1/8-male	G1/8-female	G1/4-male	G1/4-female	Spring leveler	
102.030.502.19	--	--	270.312/19	270.030	270.019	270.274	270.275	--	--
102.040.503.19	--	--	270.312/19	270.030	270.019	270.274	270.275	--	--
102.050.504.19	--	--	--	270.012	270.020	270.491	270.492	--	--
102.060.505.19	--	--	--	--	--	--	--	--	--
102.080.304.19	--	--	--	--	--	--	--	--	--
102.095.305.19	--	--	--	--	--	--	--	--	--

Dimensions

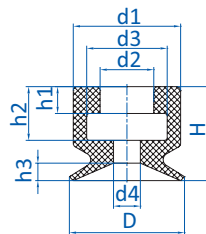

Drawing A

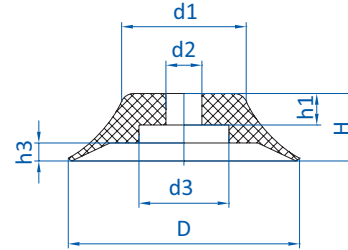

Drawing B

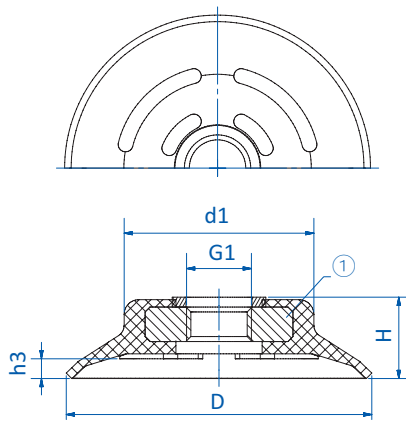

Drawing C

① = Aluminum

Item no.	Drawing	Ø D [mm]	Ø d1 [mm]	Ø d2 [mm]	Ø d3 [mm]	Ø d4 [mm]	G1	H [mm]	h1 [mm]	h2 [mm]	h3 [mm]
102.005.496.19	A	5.5	7.5	4.2	6.5	1.5	--	6.5	2	4	1
102.008.497.19	A	9.5	9	4.2	6.5	2.4	--	7	2	4	1.4
102.010.498.19	A	10.5	8.5	4.2	6.5	2	--	7.5	2	4	1.5
102.015.499.19	B	16	12	5	8	--	--	8	2.5	--	2
102.020.500.19	B	21	15	5	11	--	--	10	4.5	--	2.5
102.025.501.19	B	25.5	16	6	11	--	--	14	7	--	3
102.030.502.19	B	30	14	6	11	--	--	12	7	--	2
102.040.503.19	B	41	24	6	11	--	--	14	7	--	4
102.050.504.19	B	51	27.5	8	20	--	--	15	7	--	4
102.060.505.19	C	62	38.5	--	--	--	G1/4	16.5	--	--	4
102.080.304.19	C	82	50.5	--	--	--	G1/4	18	--	--	6
102.095.305.19	C	95	66	--	--	--	G1/4	18	--	--	6